



# HOME AUTOMAT

**avasyam**  
innovations.

**Netsoft**  
Intelligent Innovations. Smart Solutions.

Automation. Security.  
Communications

# ABOUT GROUP NETSOFT

*Empowering Business & Living...*

- *Technology Solutions: Enterprise, Hospitality & Residential*
- *Automation, Security & Communications Solutions*
- *Registered office: Bangalore; Presence: Singapore, Dubai*
- *In the last 13 years, we have catered to more than 250 clients across continents.*



Website design, development & digital Marketing.

Mission **deliver b**enefits.

Vision **P**roficient & **R**eliable **P**artner.

## HOMEAUTOMAT

*Smart Home, Apartments & Villas Solutions*

## safetrack

Tracking movements for safety



Business ERP Software. Inventory & Manufacturing.

# Security & Automation Division

Affiliates



Clients (Partial)



# Gated Community Solutions



Safe, Secure



Savings



Convenience



SMART HOME

APARTMENT & VILLAS

COMMERCIAL

# Solutions & Services



- ✓ Tablets
- ✓ Smart Phone

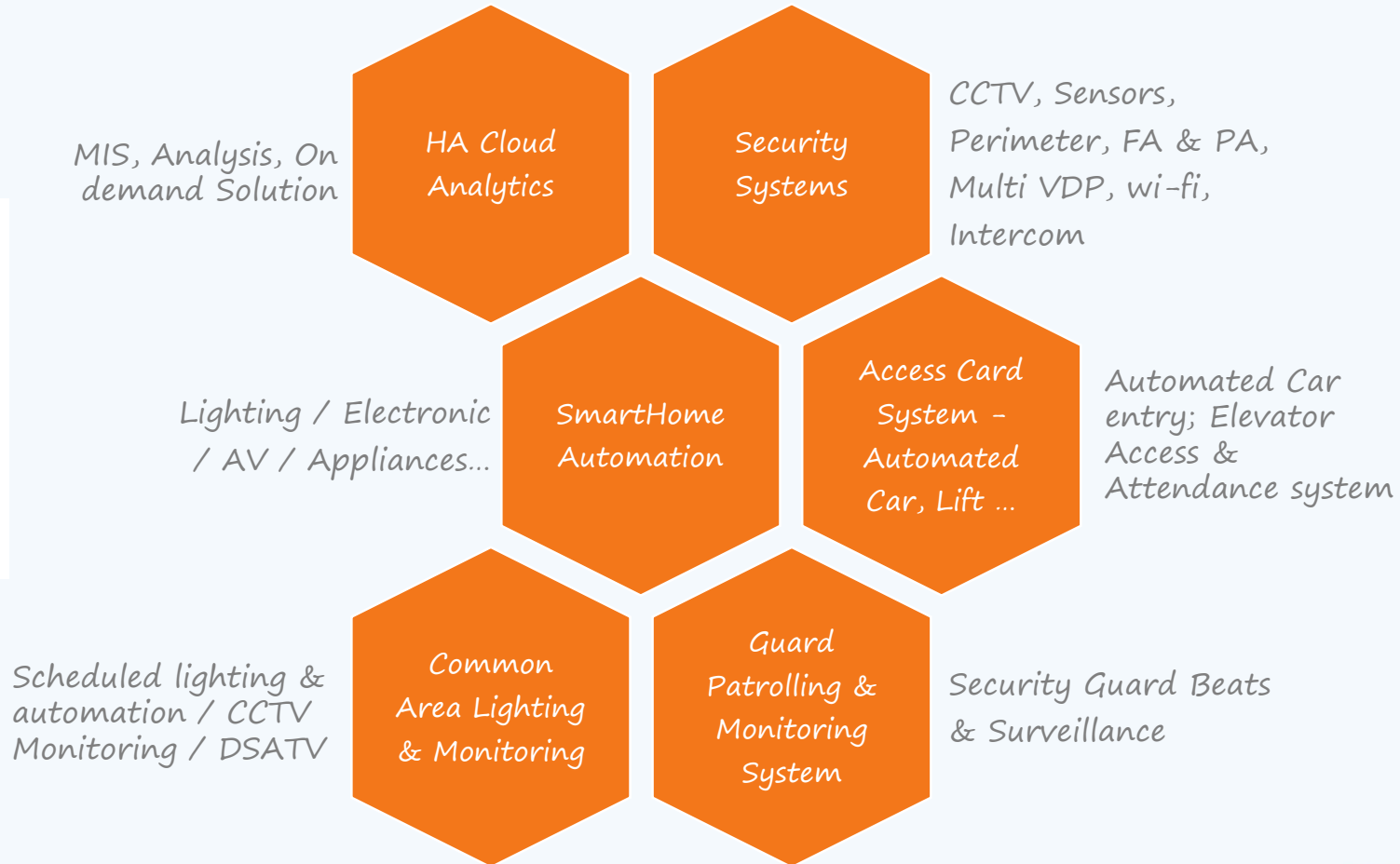

# Automation. Security. Communication.

## Automation

- Smart Home Automation
- Common Area Lighting & Gardening Automation
- Guest Room Automation
- Board Room Automation
- Nurse Care System
- AV & Projector Solutions
- Digital SATV

## Security

- Surveillance & CCTV System
- Sensors & Perimeter Solutions
- Fire & PA System
- Automated Car Access, Elevator Access, General Access System
- Guard Patrolling & Monitoring System
- Movement & Vehicle Tracking Systems
  - Kids, Student, Employees, Visitors

## Communications

- Wi-Fi Solutions
- VDP – Multi VDP or Intercom System
- HA Cloud Analytics



**HOMEAUTOMAT**

*Smart Home Automation*

# HOMEAUTOMAT

## Smart Home Automation

- *Retrofit & Wireless*
- *Energy Savings & Management*
- *Remote Access – Smart Phones or Devices and via Internet or Cloud*
- *The Green Factor*

*Lighting &  
Scene*

*Climate &  
HVAC*

*Audio &  
Video*

*Security &  
Surveillance*

*Curtain &  
Appliances*

*Water &  
Garden*

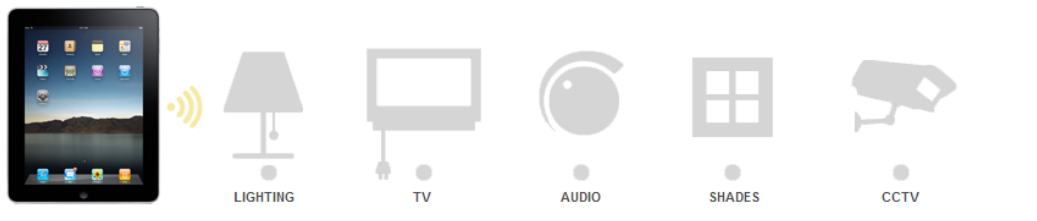





## Features

Cost effective,  
Retrofit & Wireless

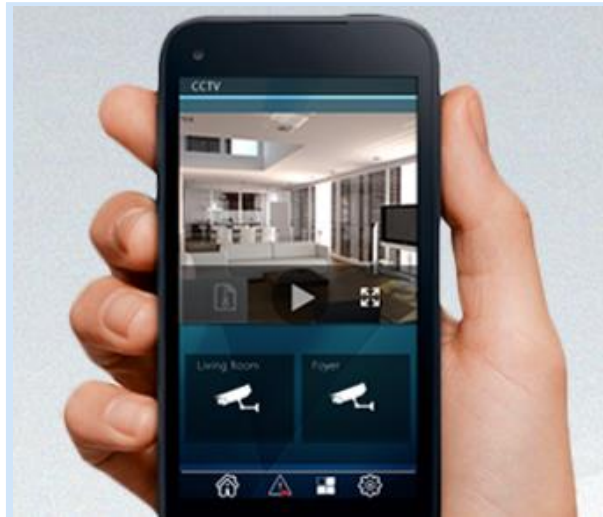

Remote Access

Smart Phone / Tablets



Energy Management

The Green Factor



## Benefits

- **Builders:**
  - A USP that stands out from the competition.
  - Higher Customer Satisfaction
  - Increase revenues
  - Powerful Marketing Tool
- **Gated Community**
  - Simplified Process
  - Informative
  - Guaranteed ROI in a year
  - Streamline residents transactions
  - Strong MIS (Management Information System)
- **General**
  - Eco-Friendly
  - Ease of use
  - Elegant design Wi-fi based works on LAN (no internet required)
  - Module based Sales & Simple Licensing Model
  - Customized



R-Fit

- Z-wave Technology
  - Wireless, Retrofit
  - Best and scalable Solution
- Features
  - Manages up to 70-300 devices
  - 500mhz – 1.6Ghz Processor, 128MB – 1GB RAM
  - \* Wi-Fi Router, USB, WAN, LAN Port(s), Recovery Disc



HOMEAUTOMAT

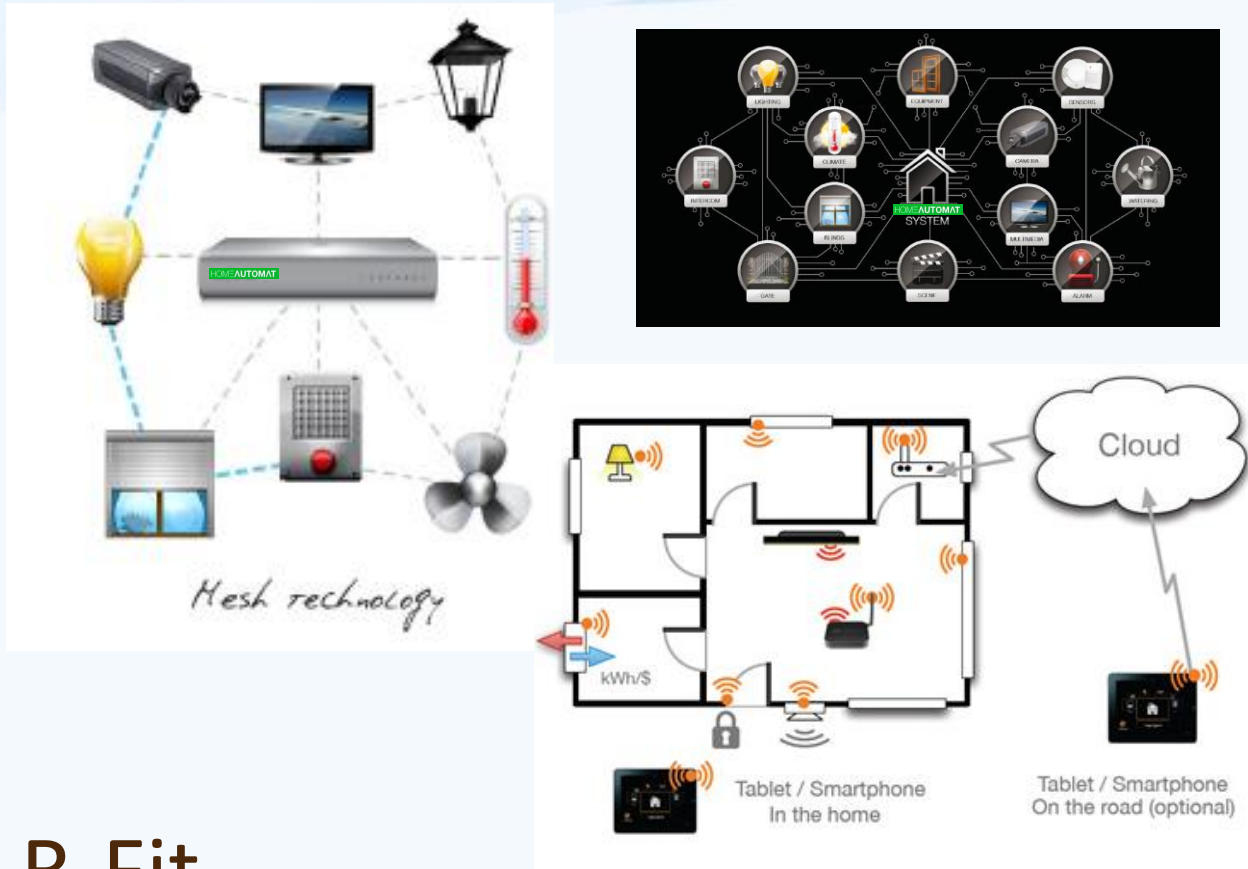

- **Wireless & Retrofit Technology**

- Mesh Technology
- Relay – ON / OFF Control
- Dimmer Control
- RGBW Controller
- IR (infra red) or Remote Module
- Sensors
- Touch Panels or Remote Control
- Cameras, DVRS Integration



R-Fit



Door & Window Sensor



Motion, PIR, Water, Flood, Shock, Vibration & Glass, Multi Sensors



Smoke, Alarm, Co2, Temperature Sensors



Switches & Sockets



Universal Remotes



IR Gateways



PAN, Tilt, Zoom IP Cameras



Energy Monitoring, Roller Shutter, Curtain, Dimmer, Door Lock

# Z-wave Accessories



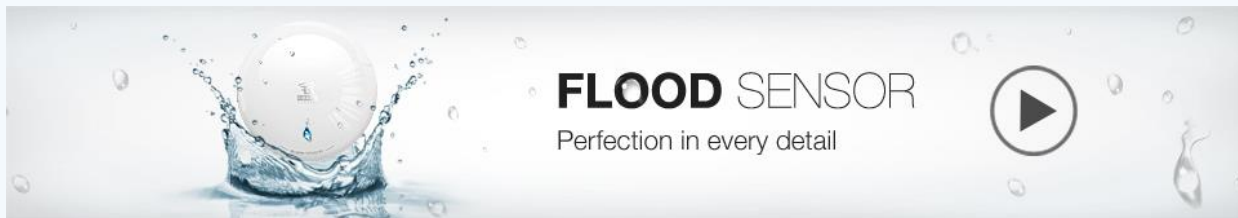
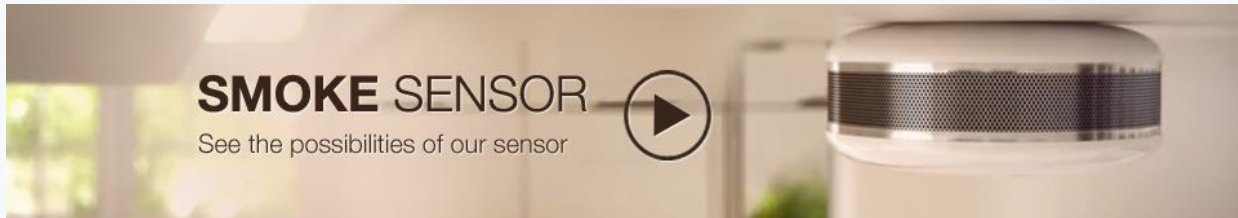
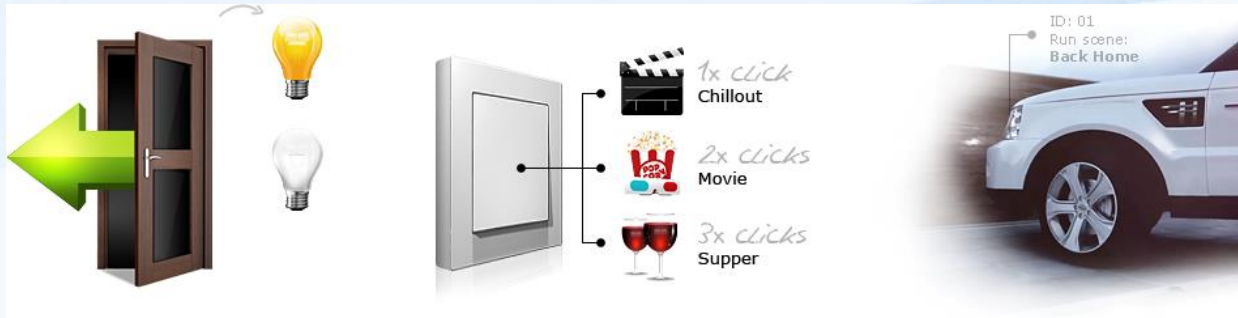



### LIGHTING

The HomeAutomat System makes it possible for you to control all the lights in the house using your mobile phone screen.



### CLIMATE

Control the climate in your house, according to your needs and expectations.



### SCENES

Thanks to the use of scenes, you won't have to perform individual, repetitive activities. Create a scene to automatically trigger many devices.



### EQUIPMENT

Use the HomeAutomat System to control roller blinds, gates, awnings and garden sprinkler systems.



### THE INTERCOM

It allows you to stay in touch with the members of your household and your guests. Call your son for dinner or invite some guests for a meal.



### ROOMS

Manage the whole room, without having to use any sub-functions.



### MULTIMEDIA

Control all the multimedia devices in your house using your mobile phone screen.



### SERVICES

HomeAutomat System can make various services arrangements based on the triggers and settings.



### SECURITY

Ensure the safety of you and your family by managing the alarm and the monitoring systems.



### SHORTCUTS

You can create your own shortcuts in order to facilitate access to a given room or scene.



## Sensors determine illumination

Use sensors to match light intensity to conditions outside. Lights may be turned on automatically when it starts getting dark and its intensity will increase after the sunset.







## Choose your favorite color

We have created an intuitive interface for your Smartphone or tablet, using which choosing your favorite color for each lighting zone is just a child's play. Favorite color bar will change coloring in a living-room or child's room like a touch of magic wand. Lighting programs slider will help you relax starting calming pastel color transitions, harmonizing with music playing in the background. There's a magic ball as well, letting you choose any color you wish. You are a wizard of your well-being.



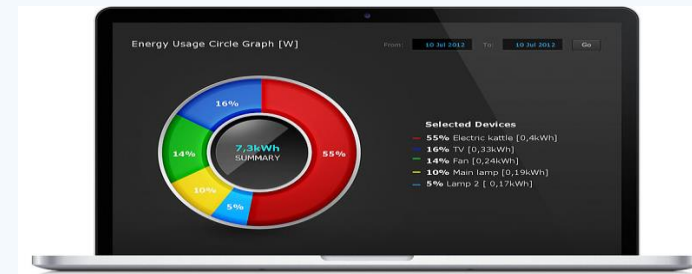

# *Automation – Home Intelligence*



## Perfect wake up

Use infinite possibilities of the HomeAutomat System for your comfort and convenience during everyday morning activities.



6:00 am

Central unit of the HomeAutomat System collects meteorological data, using which it customizes number of scheduled activities, such as adjusting temperature inside the house to your morning needs and habits.

7:15 am

Temperature in your house is now perfect. The house gently wakes you up by playing tunes from your favorite radio station, gradually increasing the volume.

7:20 am

Roller blinds pull up gently and your bedroom is flooded with natural light. In wintertime, the system turns on the light on 30% brightness, allowing your eyesight to gradually adjust to daylight.

7:25 am

Your eyes are open. The system senses motion in the bedroom and lights your way to the bathroom and the kitchen.

7:26 am

Bathtub fills with hot water while coffee maker turns on. The TV turns on. There's nothing like the latest world news...

7:30 am

Roller blinds pull up gently and windows open slightly to let a breath of air into your house.

7:50 am

You go back to aired bedroom. The system displays weather information on TV screen, thanks to which you dress appropriately for the weather. Your favorite music is played in the background.

8:00 am

It's time to leave for work. The house turns off all devices, arms alarm system, pulls down roller blinds and locks the doors. Your house is now safe.



## The return home

After a hard day's work you deserve a rest. All you dream about is getting back home. Inform the Fibaro System and have it await your arrival. Create the right atmosphere in the house and ensure your comfort and convenience.

6:00 pm

The system knows the evening approaches sensing reduced intensity of the light outside. It turns on the garden lighting and the fountain.

6:10 pm, you get back from work

The system senses your car approaching the property. Increases the brightness of lighting in the garden and in the driveway to 100%. Opens the gate and the garage door. Turns on the light in the garage.

6:15 pm, you drive into the garage

If CO detector senses deterioration of air quality in the garage, the fan is turned on, to drive the exhaust fumes outside.  
If CO concentration is too high may threaten your life, garage door will remain open until the garage is aired.

6:20 pm, you enter th house

The alarm system is deactivated.  
If it's dark, all the roller blinds are pulled down.  
Lights are turned on in all the rooms where motion is detected.  
The TV turns on to your favorite channel\*.

6:22 pm

WATER THE GARDEN scene is activated.  
Brightness of the light in the garden is reduced to 50%.  
Sprinklers are activated and water the garden.

6:25 pm

Your neighbor joins you for a football match.  
Before you let him into the house, you talk to him on the phone, which is connected to the intercom.  
When you open the gate, brightness of the garden lighting is increased to 100% and sprinklers are turned off, so as not to get your guest wet.\*



# On fire

In critical situations, immediate response to threat is the most important factor, which often can save our lives. FIBARO will identify a threat within seconds, warn you of the danger and activate all the pre-programmed alarm procedures, thus preventing a tragedy from happening.



1:03:12 am

The smoke detector sends a signal to the Fibaro System central unit, informing it of the threat of fire in your house.

1:03:14 am

The system immediately implements emergency procedures and warns you of the danger.

1:03:15 am

The alarm system is activated, while all the lights in the house are switched into flash mode to make the threat clearly visible to the appropriate services and to your neighbors.

1:03:17 am

The Fibaro System opens all the windows in the house, pulls up all the roller blinds, opens the garage door and unlocks all the doors.

1:03:18 am

The system cuts off the gas supply. At the same time, the ventilation system is activated, on 100% power.

1:03:21 am

The thermostats and the air conditioning control devices are immediately disconnected, which prevents smoke from spreading in the house.

1:03:22 am

All the audio and video devices play warning messages and evacuation instructions.

1:03:23 am

Special pre-configured lighting guides the members of the household to the exit through an escape route.



1:03:12 am

Smoke

alarm

OK

firefighters

Fibaro is concerned with your safety



## I-Systems

- Intelligent Systems
  - Wireless
  - Stylish, Elegant and Intelligent Solutions
- Features
  - Elegant accessories that gives complete Home Automation
  - Wi-Fi based Solution

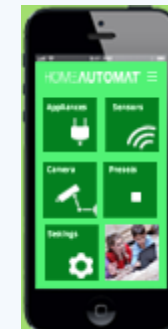

HOMEAUTOMAT



Intelli Feather touch switches with sensors

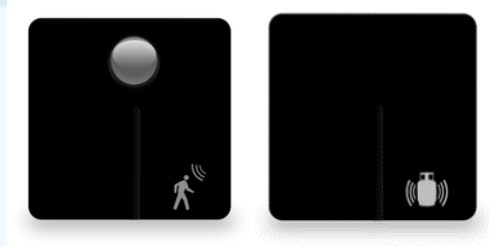

Motion, Gas & Other Sensors



Video Door Phone



IR Gateways



PAN, Tilt, Zoom IP  
Cameras

# Intelli Accessories



# Common Area Lighting & Gardening Automation



- Lighting & Gardening Automation
- Scheduling
- Sensor based Lighting.



HOMEAUTOMAT

# Guest Room Automation

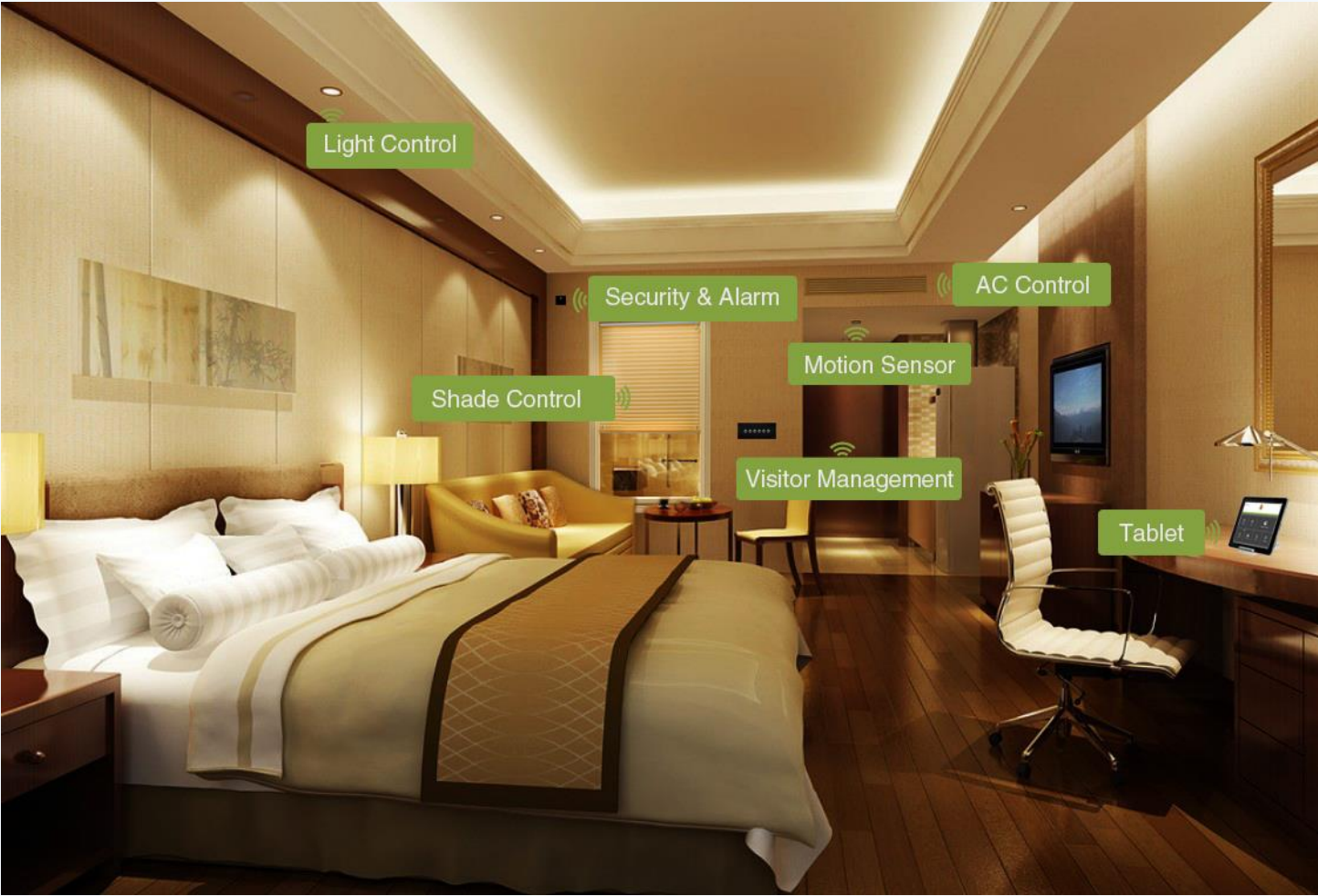

# Health Care System – Nurse Call, Patient Management

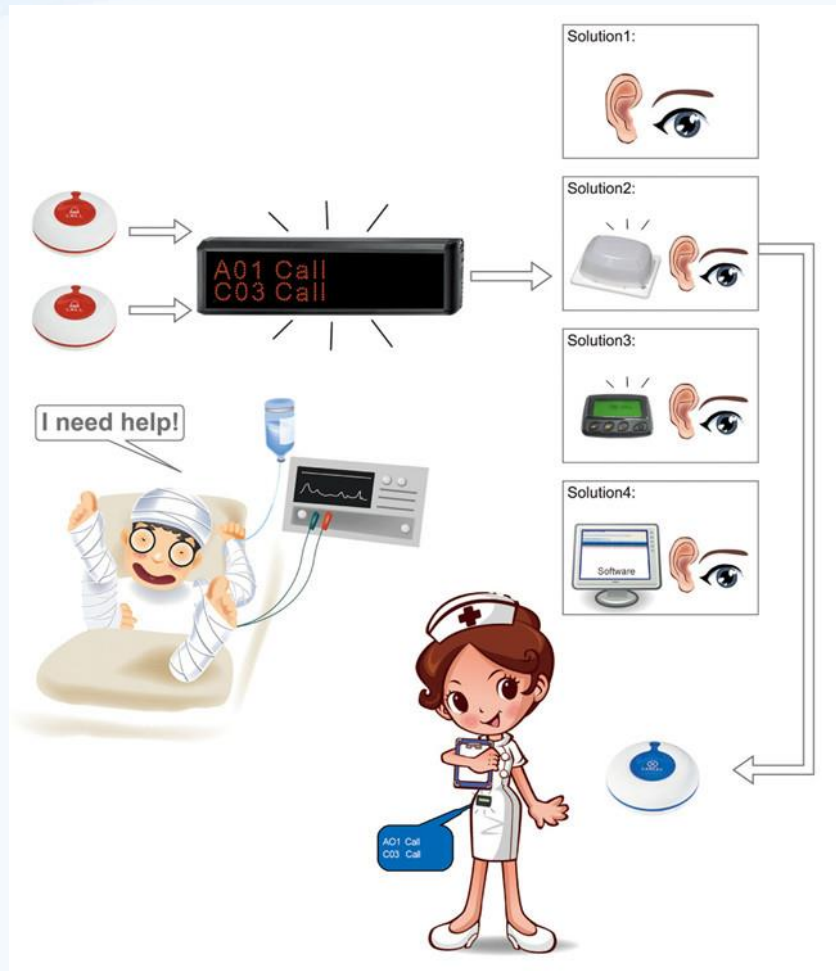

NS Display



Electronic / Toilet Calling Unit



\* Door Indicator  
\* Nurse Station Supervisory Controller



Token Management System



# Board Room Automation



## Lighting & Scene Automation



## Projector & AV Solution



## Telepresence Solution



# Digital Satellite TV Solutions

- *Digital TV offers customized cost-effective technology solutions for networks of any size*
- *Solutions are based on reliability, quality, functionality and design*
- *Delivers crystal-clear 100% digital picture and sound – in HD and SD – to every TV in Apartments / Hotels and other network*





# Security Solutions

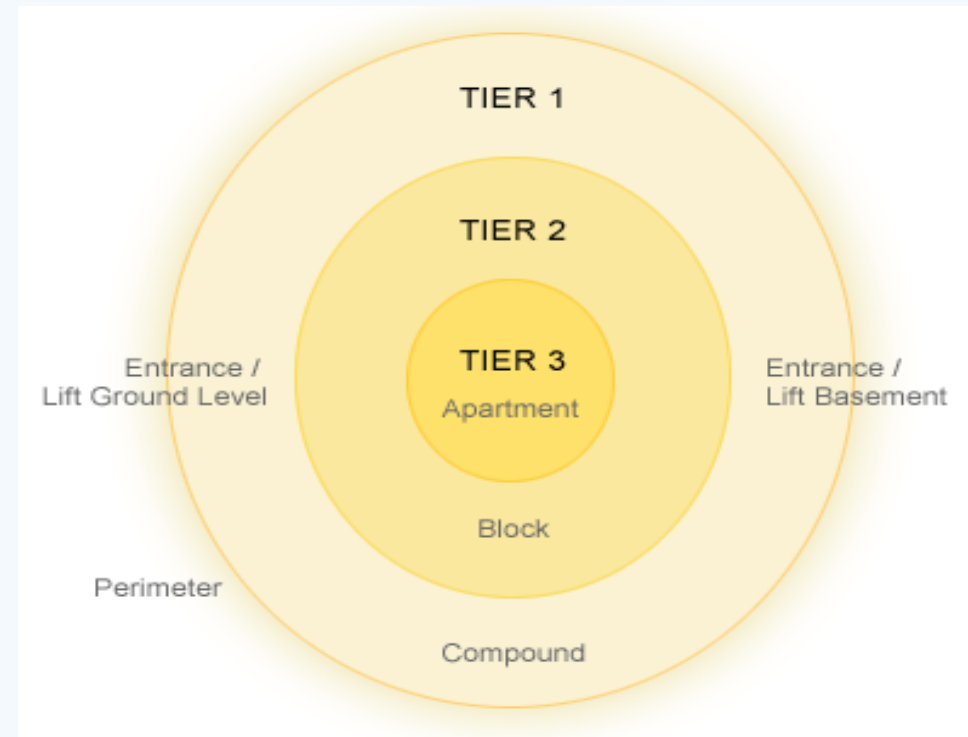

HOMEAUTOMAT

# Security Solutions

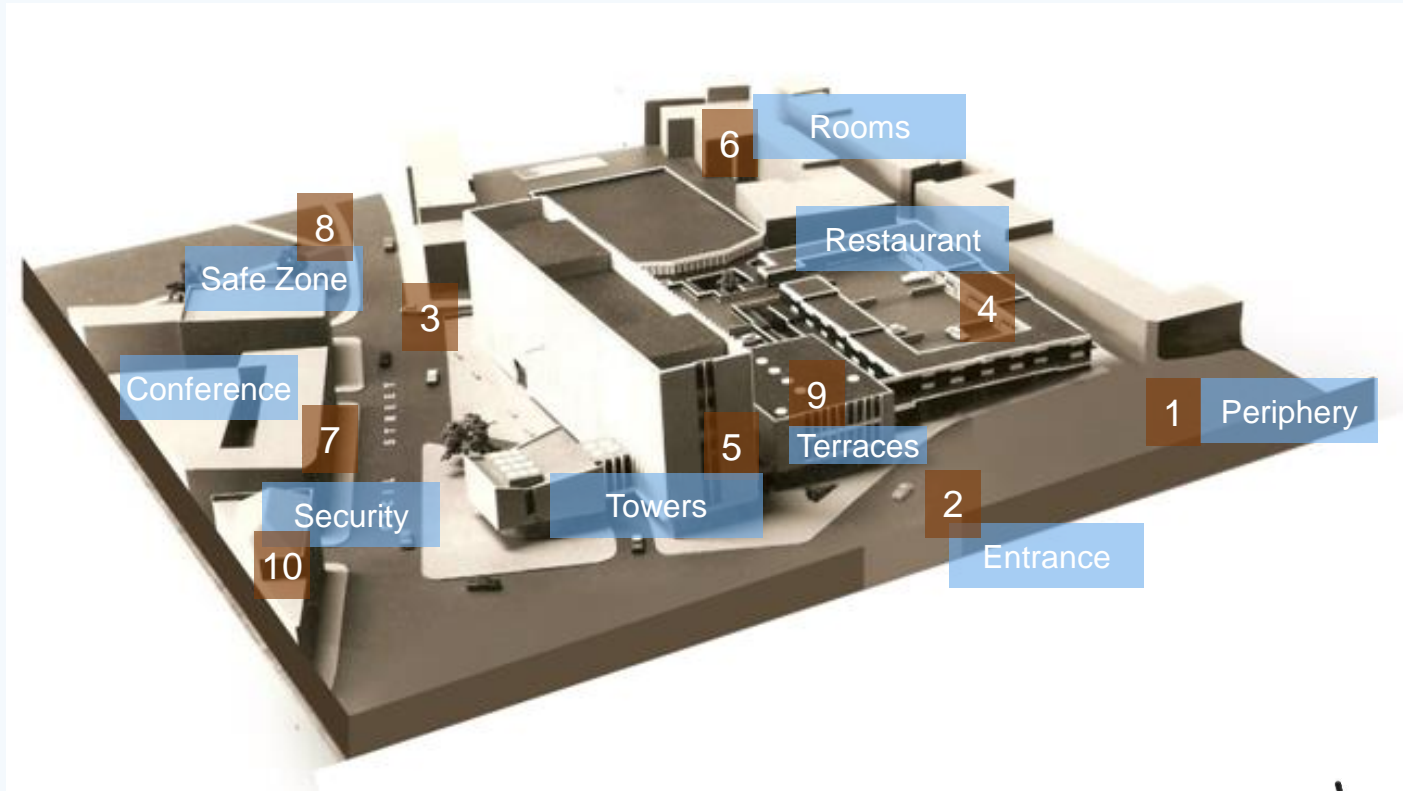

**1** Periphery Surveillance  
Create additional surveillance around the premises

**2** Visitor Management  
Screen visitors and maintain records

**3** Outdoor Surveillance  
Monitor your premises

**4** Indoor Surveillance  
Monitor discreet places

**5** Public Address System  
Easy communication across your network

**6** Fire, Gas & Smoke Leakage  
Protect your building from any mishap

**7** Secure Access System  
Biometric or Facial Recognition based entry

**8** Intrusion Detection & Alarm System  
Set up safe zones in your premises

**9** Common Area Appliance Control  
Lights that switch on automatically as you walk by

**10** Centralized Control Station  
Monitor & Control through a unified single interface



# Automated Car Entry

*Car parking for the authorized residents' cars based on RFID with automatic entry / exit point opening.  
Simplified Car Parking Solutions.*

Mid range to Long range  
RFID Systems

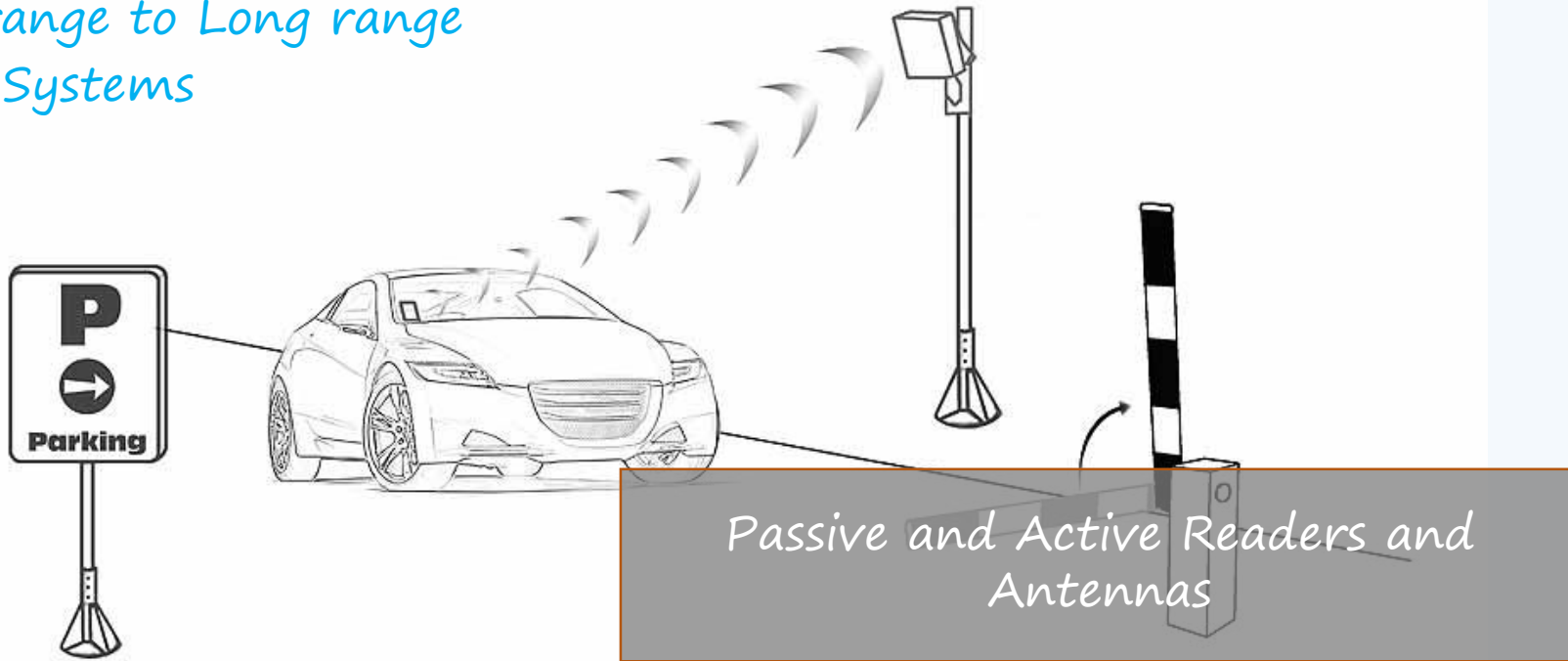



# Automated Car Entry

## Mid-Range Access Control



Use 10 to 100 cm readers' range to authenticate the driver of the cars. It can be done together with long range identification of the car.

## Long Range Access Control



Use UHF passive tags or Active tags for authenticating the driver or the car itself. With windshield tags and UHF readers, you can read up to 15 meters.

# Automated Car Entry

*Car parking for the authorized residents' cars based on RFID with automatic entry point opening.  
Simplified Car Parking Solutions.*



HOMEAUTOMAT

# Automated Car Entry

*Car parking for the authorized residents' cars based on RFID with automatic entry point opening. Simplified Car Parking Solutions.*



# Automated Car Entry

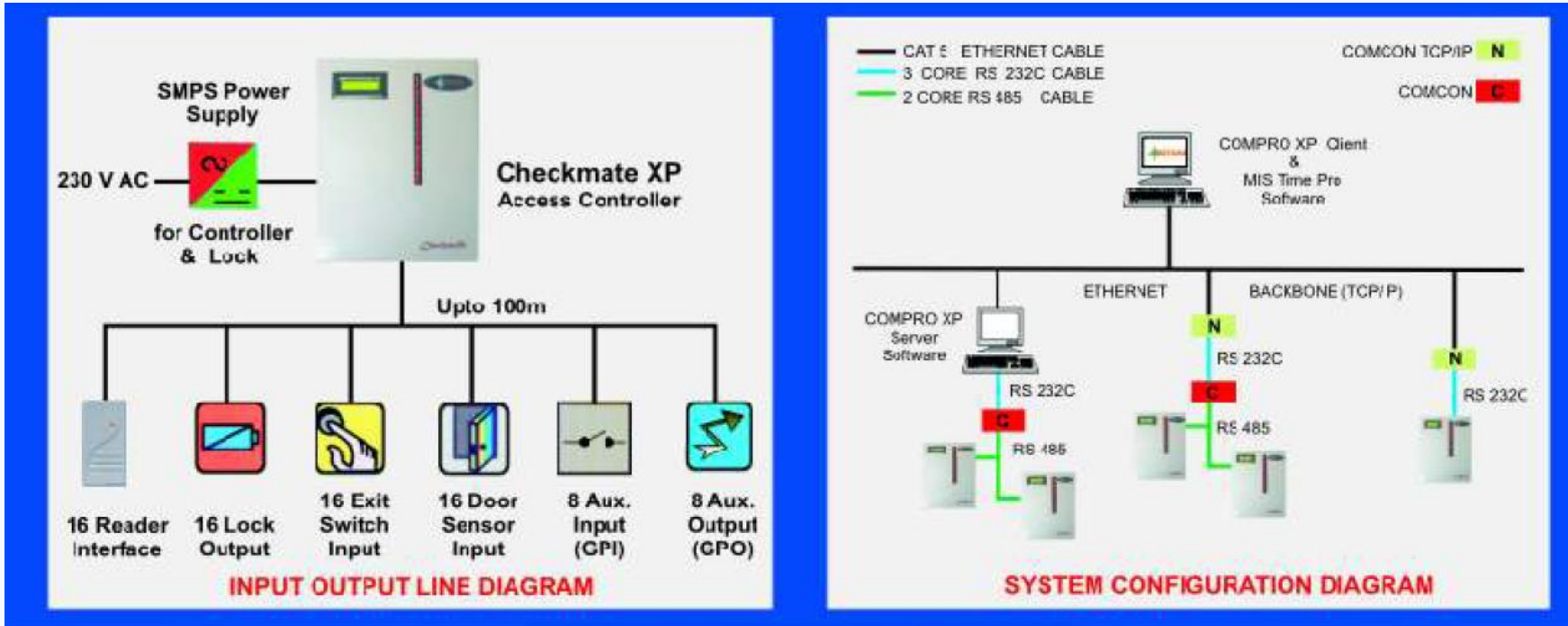

# Access based Elevator

*Secured access to residents.*



Visitor, Residents, Maid servant and others has to flash the card and then select the floor to use the lift.

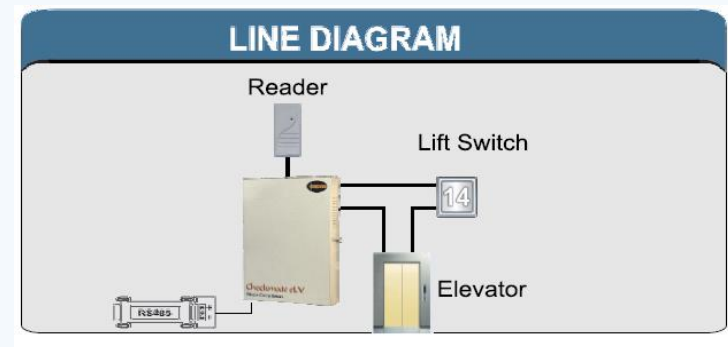

# Access Systems

Secured access to specific areas.



Biometric,  
Face Recognition,  
Card based,  
Digital



Special Access system  
for Kids Safe or  
Cab System



HOMEAUTOMAT

# Secure Watch

Guard Patrolling & Monitoring System (SW GPMS)



Hotspots



HOMEAUTOMAT

# Secure Watch

Guard Patrolling & Monitoring System (SW GPMS)

- Data downloaded from handheld shall provide you quick reports like 'by Device wise', by Location wise, un visited location based on date.
- The reports can be emailed from the system.
- HA-Cloud is a web interface of the Secure watch solution.
- If the data is not uploaded within 24 hours from the last upload, the HA-Cloud shall send an alert to the immediate supervisor.
- The HA-Cloud shall email the respective email ids the required report as per their choice.
- The HA-Cloud provides various Graphical reports of the solution.
- The HA-Cloud is Smart Phones browser friendly.

HA-Cloud Features



# Secure Watch

Guard Patrolling & Monitoring System (SW GPMS)

The screenshot shows the HOMEAUTOMAT web interface. At the top, there is a header with the logo, a search bar, and navigation links for Dashboard, Widgets, Charts, UI Elements, Forms, Tables, Calendar, Mailbox, and Examples. A date range selector is set to 06/18/2014 - 06/18/2014. Below the header, there is a list of projects under the PRANAVA category. Each project has a checkbox and a list of systems: Pranava Lotus Park (Secure Watch, Automated Car Entry, Elevator Access System), Pranava Gokhuldhham (Secure Watch, Automated Car Entry, Elevator Access System), and Pranava Gitaar. A pagination bar at the bottom shows 'Showing 1 to 10 of 57 entries' and navigation buttons for Previous, 1, 2, 3, 4, 5, and Next.

The screenshot shows the HOMEAUTOMAT web interface for a Project Overview. The header includes the logo, a search bar, and navigation links for Dashboard, Widgets, Charts, UI Elements, Forms, Tables, Calendar, Mailbox, and Examples. A date range selector is set to 06/18/2014 - 06/18/2014. The main content area features a line chart titled 'Overview' showing data from 2012 to 2013. Below the chart are four data cards: Total Visits (150), Guards/Device (53%), Locations (44), and Avg. Visits (65%). A Donut Chart is also visible on the right side of the dashboard.

Year	Total Visits	Guards/Device	Locations	Avg. Visits
2012	~5,000	~50%	~10	~50%
2013	~22,000	~53%	~44	~65%

HA-Cloud interface

HOMEAUTOMAT

# Secure Watch

*Guard Patrolling & Monitoring System (SW GPMS)*

- *HomeAutomat offers a comprehensive range of Guard Patrolling & Monitoring System.*
- *Guard patrolling is essential to make sure that the gateway or the premises is safe and secure.*
- *Security guard shall carry a hand held reader to the specific hotspots (a location where RFID tags are placed) and the reader records the date and time of the security guard visit to the hotspot.*
- *These data is further available for the management for a detailed analysis.*

*A Brief...*

HOMEAUTOMAT

# safetrack

*Tracking Movements for safety*



- *Netsoft has partnered with Politron to give a complete Safety solution based on RFID or other communication networks.*
- *Netsoft's solutions under the brand name 'SafeTrack' includes:*
  - *KidSafe – Vehicle & Student Tracking System.*
  - *SmarTrack – Vehicle & Employee Tracking System with special module for cab management.*
  - *Walkfree – Human or Asset Tracking within the campuses or specific locations.*
- *SafeTrack is a cloud based solution with user interface on browser or on mobile smart devices, with alerts messages – SMS / Email / Push notification.*



# Vehicle Tracking system

## KIDS SAFE, LOGISTICS & CABS



- Safety solution for the kids tracking who travel in school / private Vehicles.
- Advanced GPS tracking solution with two way communication features with driver and parents (optional).
- A reliable solution to track the children exact location in the move or at school.
- State of the art technology uses Tablet or Smart Phones for the solution.
- Remote Web monitoring and control
- Smart driver dash board
- Guides driver to next kid pickup
- Fully automated with 0 manual interruption.



# Communications Solutions

HOMEΛUTOMAT

# Wi-fi Zone System

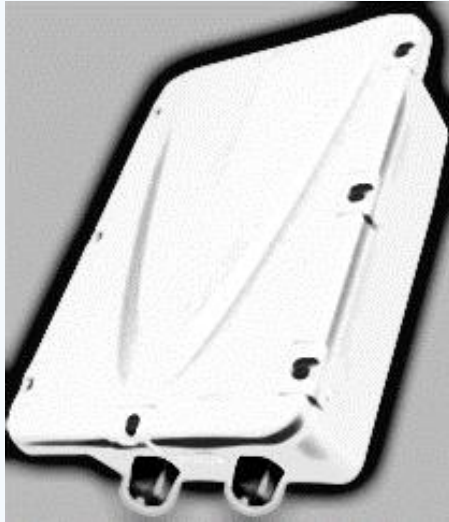

- AON 322 Wireless Outdoor Enterprise CB/AP features a 13dBi High Gain Antenna dual polarization with high output power and high sensitivity that can extend the transmission range to deliver a stable wireless connection.
- 4 Operation Modes:
  - Access Point
  - Client Bridge
  - Client Router
  - WDS

# Multi VDP or intercom System



# Multi VDP or intercom System

- **Intercom system** – This solution replaces the traditional telephone based intercom system. Security personal shall be given a Tablet and the visitor can speak to the resident through wireless network with two way or one way video. Upon Residents confirmation the visitor is allowed inside the gated community.
- This intercom system shall allow the residents of the community to have a voice or video talks internally
- Provision to leave a recorded audio or video messages to the other residents.
- Gated community alerts or reminders shall be sent through this solution (eg. maintenance personal can send alert to all the residents much before for any scheduled maintenance activity).
- **VDP – Video Door Phone** at each houses shall ensure the visitor is being looked before allowing access to enter into the villa.



# Multi VDP or intercom System

- *Video Door Phone with integrated IP Camera features include:*
- *Two way audio, one way video communication with single touch UI that enables resident to easily converse with visitor*
- *Ability to take video door phone call from your personal tablet using Orvito apps*
- *Infrared (IR) camera on the outdoor unit to provide clear images of*
- *Visitors even during night/low light situations*
- *Automatically records images/videos of visitors for added security*
- *Remote alert feature to alert resident on the smartphone*
- *Video message feature for visitors to leave a message if the resident is away*
- *Remote camera activation from the indoor unit to discreetly monitor/record any suspicious activity*

Graphical Representation of our various services



# HA Cloud - Web & Software Solutions

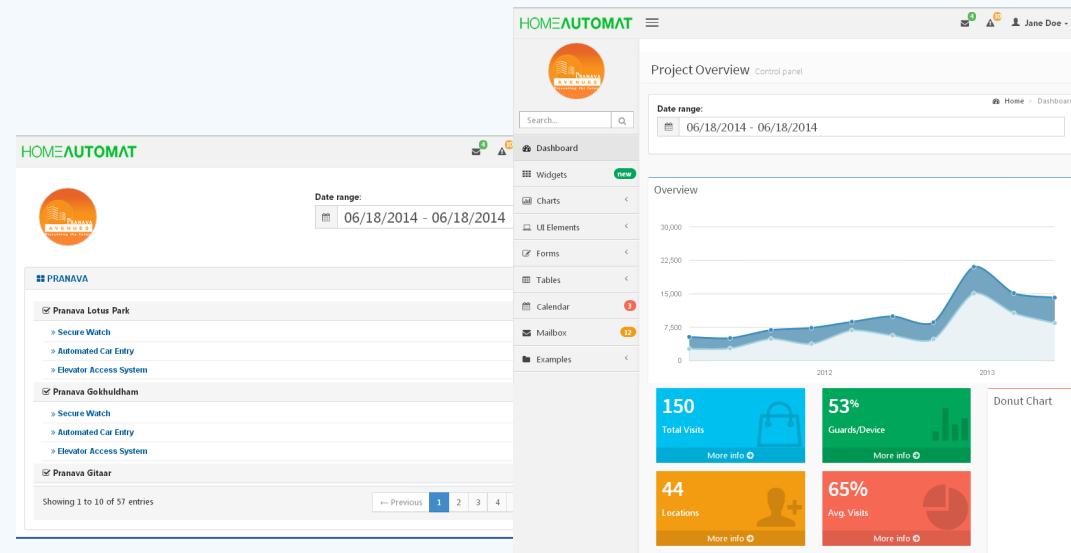

Guard Patrolling, Vehicle Entry, Elevator Access, Common Access Systems, CCTV on cloud

# Thank you



Netsoft Group -  
Netsoft Microsystems | Avasyam Innovations,  
No. 2453, 2<sup>nd</sup> Floor, 9 Main, 17 E Cross, BSK II Stage,  
Bangalore - 560070, Karnataka, India

<http://www.homeautomat.in>  
[automation@netsoftindia.in](mailto:automation@netsoftindia.in) [sales@homeautomat.in](mailto:sales@homeautomat.in)

Chat: rm.sudhakar (skype / yahoo / gtalk)

Contact: Sowmya - +91 98451 475111,  
RM Sudhakar +91 98867 95676  
Sushma +65 9069 2324

Look forward for  
the opportunity  
to work with  
you.

HOMEAUTOMAT